

# The Custom Shop at Lillian August

## CMFBD01W Custom Shop Chair

C = Classic 39" Depth  
 MF = Modern English Arm to the Front  
 B = Box Back  
 D = Double Needle Weltless  
 01 = Chair  
 W = Wedge Leg  
 Overall: W32 D39 H35  
 Classic Seat Inside Depth: 22  
 Arm height: 25 Seat height: 19  
 Standard finish: Antique Walnut  
 Shown in optional finish: Modern Elm  
 Optional #1-BB nail trim on arms shown



## LTFBE01S Custom Shop Chair

L = Luxury 42" Depth  
 TF = Track Arm to the Front  
 B = Box Back  
 E = English Seam Weltless  
 01 = Chair  
 S = Small Wood Base  
 Overall: W32 D39 H35  
 Luxury Seat Inside Depth: 25  
 Arm height: 25 Seat height: 19  
 Standard finish: Antique Walnut  
 Shown in optional finish: Mineral  
 Optional #1-P nail trim spaced on arms  
 and around base shown



## CTTBD82W Custom Shop Sofa

C = Classic 39" Depth  
 TT = Track T-Cushion  
 B = Box Back  
 D = Double Needle Weltless  
 82 = (2) Cushion 85" Sofa  
 W = Wedge Leg  
 Overall: W85 D39 H35  
 Classic Seat Inside Depth: 22  
 Arm height: 25 Seat height: 19  
 Two Seat Cushions  
 Standard finish: Antique Walnut  
 Shown in optional finish: Mineral  
 Standard with two 20" x 20" throw pillows  
 Optional #1P nail trim around base shown



## LXXE50P Custom Shop Ottoman

L = Luxury Depth 37"  
 X = Not Applicable  
 X = Not Applicable  
 E = English Seam Weltless  
 50 = Sectional Ottoman  
 P = Plinth Base  
 Overall: W37 D37 H19  
 Also Available: Classic Size: W34 D34  
 Standard finish: Antique Walnut  
 Shown in optional finish: Gold Leaf  
 Optional #1-BB nail trim spaced shown



## LSFBS Custom Shop Sectional

L = Luxury Depth 42"  
 SF = Scallop Arm to Front  
 B = Box Back  
 D = Double Needle Weltless  
 S = Small Wood Base

## LSFBD13S Left Arm Loveseat

W56 D42 H35  
 Standard with (1) 20" X 20" Throw Pillow

## LXXBD15S Curved Corner

W77 D42 H35  
 Standard with (1) 20" X 20" Throw Pillow  
 X = Not Applicable

## LSFBD14S Right Arm Loveseat

W56 D42 H35  
 Standard with (1) 20" X 20" Throw Pillow

Luxury Seat Inside Depth: 25  
 Arm height: 25 Seat height: 19  
 Standard finish: Antique Walnut  
 Shown in optional finish: Medium Antique



# The Custom Shop

## at Lillian August

It's easy to order your own custom upholstered pieces. Just follow this illustration and fill in the appropriate box with the chosen letters.

depth | arm/cushion style | back | seam | frame style | base

### 1 Select Depth



**C** = Classic 39"



**L** = Luxury 42"

### Custom Shop Standards:

Loose Pillow Back      Seat Height: 19"  
 Height: 35"              Classic Seat Depth: 22"  
 Arm Height: 25"        Luxury Seat Depth: 25"

### 2 Select Arm/Cushion Style

Arm to the Front



**TF** = Track Front



**MF** = Modern English Front



**CF** = Crescent Front



**SF** = Scallop Front



**RF** = Rolled Front

T-Cushion Arm



**TT** = Track T-Cushion



**MT** = Modern English T-Cushion



**CT** = Crescent T-Cushion



**ST** = Scallop T-Cushion



**RT** = Rolled T-Cushion

### 3 Select Back Style



**B** = Box Back



**K** = Knife Edge

### 4 Select Seam



**W** = Welt



**E** = English Seam Weltless



**D** = Double Needle Weltless

### 5 Select Frame Style

1/4" = 1' Scale (Approximate)

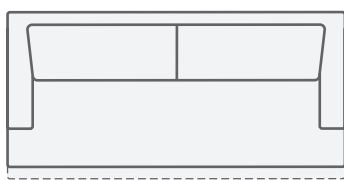
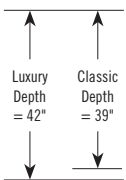

**81** = 1 Cushion  
85"W

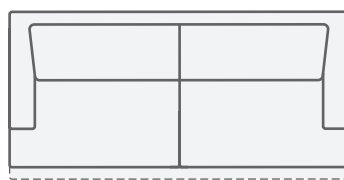

**82** = 2 Cushion  
85"W

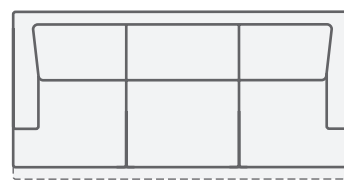

**83** = 3 Cushion  
85"W

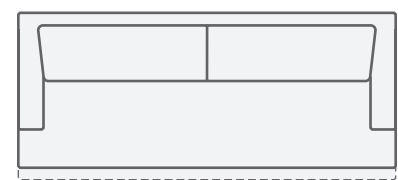

**91** = 1 Cushion  
95"W

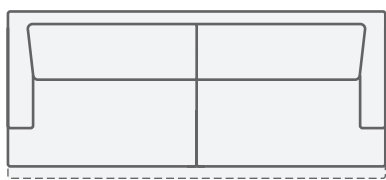
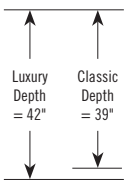

**92** = 2 Cushion  
95"W

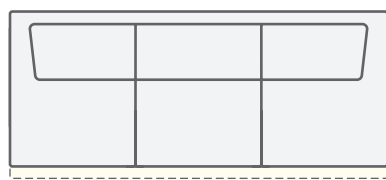

**93** = 3 Cushion  
95"W

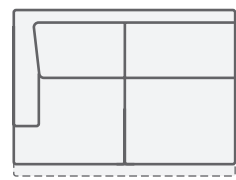

**13** = Left Arm Loveseat  
56"W

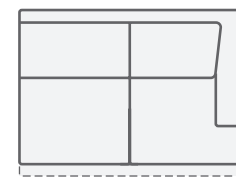

**14** = Right Arm Loveseat  
56"W

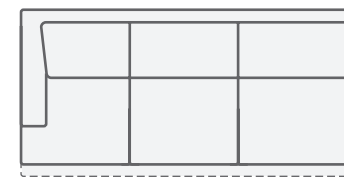

**31** = Left Arm Sofa  
82"W

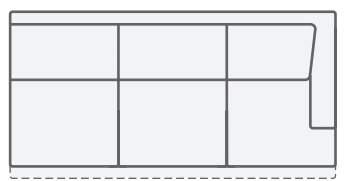
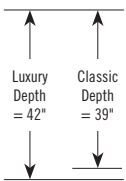

**32** = Right Arm Sofa  
82"W

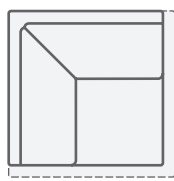

**17** = Corner Chair

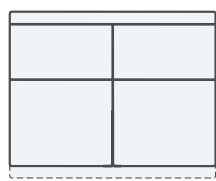

**18** = Armless Loveseat  
52"W

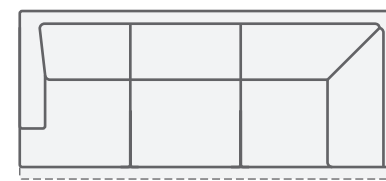

**33** = Left Arm Corner Sofa  
94 / 98"W

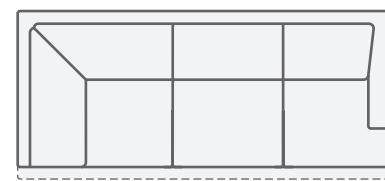

**34** = Right Arm Corner Sofa  
94 / 98"W

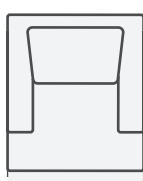
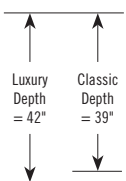

**01** = Chair  
32 / 35"W\*



**20** = Ottoman  
29"W 19"D

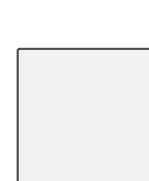

**C50** = Ottoman  
34"W 34"D

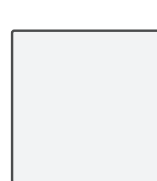

**L50** = Ottoman  
37"W 37"D

\*01 - Chair Widths:  
Track, English & Scallop Arm = 32"  
Crescent & Roll Arm are wider = 35"

Sectional Ottomans:  
Width Matches Depth Selected

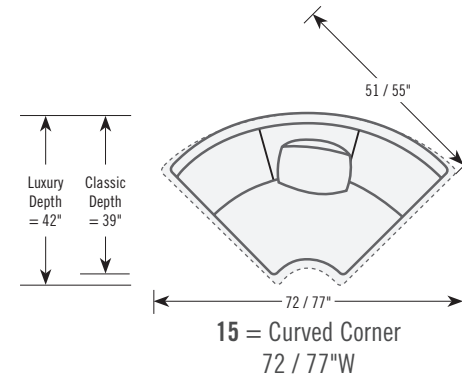

**15** = Curved Corner  
72 / 77"W

### 6 Select Base



**D** = Dressmaker



**S** = Small Wood



**L** = Large Wood



**R** = Reeded



**P** = Plinth



**W** = Wedge